



UNIFIED CYBER OLYMPIAD (UPDATED)

CLASS - 10
Question Paper Code : 3B107

KEY

1. B	2. A	3. C	4. D	5. C	6. B	7. A	8. A	9. C	10. D
11. D	12. D	13. C	14. B	15. D	16. A	17. C	18. A	19. B	20. C
21. B	22. B	23. A	24. A	25. C	26. D	27. A	28. B	29. D	30. C
31. C	32. C	33. A	34. A	35. C	36. B	37. B	38. B	39. B	40. B
41. C	42. B	43. C	44. C	45. B	46. D	47. C	48. C	49. D	50. D

SOLUTIONS

MENTAL ABILITY

01. (B)
$$\left(\frac{3x^2}{5} + \frac{11x}{5} - 4\right) = \left(\frac{3x^2 + 11x - 20}{5}\right)$$

$$= \frac{1}{5} [3x^2 + 11x - 4x - 20]$$

$$= \frac{1}{5} [3x(x+5) - 4(x+5)]$$

$$= \frac{1}{5} (x+5)(3x-4)$$

$\therefore (x+5)$ is a factor of $\left(\frac{3x^2}{5} + \frac{11x}{5} - 4\right)$

02. (A) Given $a = 89$ cm, $b = 116$ cm, $c = 123$ cm

$$s = \frac{a+b+c}{2} = \frac{89 \text{ cm} + 116 \text{ cm} + 123 \text{ cm}}{2}$$

$$= \frac{328 \text{ cm}}{2} = 164 \text{ cm}$$

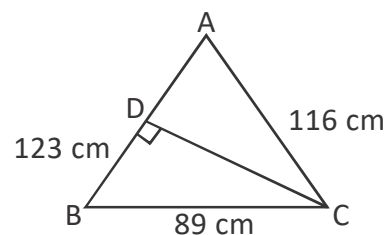

$$\text{Area of } \triangle ABC = \sqrt{s(s-a)(s-b)(s-c)}$$

$$= \sqrt{164 \times 75 \times 48 \times 41} \text{ cm}^2$$

$$= \sqrt{41 \times 2 \times 2 \times 3 \times 5 \times 5 \times 4 \times 4 \times 3 \times 41} \text{ cm}^2$$

$$\text{Area of } \triangle ABC = 41 \times 2 \times 3 \times 5 \times 4 \text{ cm}^2$$

$$\frac{1}{2} \times AB \times CD = 4920 \text{ cm}^2$$

$$\frac{1}{2} \times 123 \text{ cm} \times CD = 4920 \text{ cm}^2$$

$$CD = 4920 \text{ cm}^2 \times 2 \times \frac{1}{123 \text{ cm}} = 80 \text{ cm}$$

03. (C) Given $r = 3.5 \text{ cm}$ and $r + h = 15.5 \text{ cm}$
 $\therefore h = 15.5 \text{ cm} - 3.5 \text{ cm}$
 $h = 12 \text{ cm}$

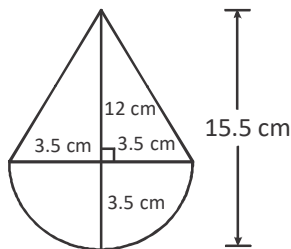

Given height of cone (h) = 12 cm and radius = 3.5 cm

$$\therefore \text{Slant height of cone } (l) = \sqrt{h^2 + r^2}$$

$$= \sqrt{12^2 + 3.5^2}$$

$$= \sqrt{144 + 12.25} = \sqrt{156.25}$$

$$l = 12.5 \text{ cm}$$

Total surface area of the toy = CSA of the cone + CSA of the hemisphere

$$= \pi r l + 2\pi r^2 = \pi r (l + 2r)$$

$$= \frac{22}{7} \times 3.5 (12.5 + 2 \times 3.5) \text{ cm}^2$$

$$= 11 \times 19.5 \text{ cm}^2$$

$$= 214.5 \text{ cm}^2$$

04. (D) Given $6a^2 = 294 \text{ cm}^2$

$$a^2 = \frac{294}{6} \text{ cm}^2 = 49 \text{ cm}^2$$

$$a = (7 \text{ cm})^2$$

$$\therefore \text{Volume of cube} = a^3 = 343 \text{ cm}^3$$

$$\text{Given } \pi r^2 h = 343 \text{ cm}^3$$

$$\Rightarrow \frac{22}{7} \times r^2 \times \frac{49}{22} = 343 \text{ cm}^3$$

$$r^2 = \frac{343}{7} \text{ cm}^2 = 49 \text{ cm}^2$$

$$r = 7 \text{ cm}$$

$$\text{CSA of cylinder} = 2\pi r h$$

$$= 2 \times \frac{22}{7} \times 7 \times \frac{49}{22} = 98 \text{ cm}^2$$

05. (C) Let $\frac{1}{\sqrt{x}} = a$ and $\frac{1}{\sqrt{y}} = b$

$$\text{Given } 2a + 3b = \frac{2}{3}$$

$$3(2a + 3b) = 2$$

$$6a + 9b = 2 \quad \dots\dots (1)$$

$$4a - 9b = \frac{-1}{3}$$

$$12a - 27b = -1 \quad \dots\dots (2)$$

$$12a - 27b = -1 \quad \dots\dots (2)$$

$$12a + 18b = 4 \quad \dots\dots (1) \times 2$$

$$\begin{array}{r} (-) \quad (-) \quad (-) \\ \hline \end{array}$$

$$-45b = -5$$

$$b = \frac{-5}{-45}$$

$$b = \frac{1}{9} = \frac{1}{\sqrt{y}}$$

$$\sqrt{y} = 9$$

$$6a + 9 \times \frac{1}{9} = 2 \quad \dots\dots (1)$$

$$6a + 1 = 2$$

$$6a = 2 - 1$$

$$a = \frac{1}{6} = \frac{1}{\sqrt{x}}$$

$$\sqrt{x} = 6$$

$$x = 6^2$$

$$x = 36$$

$$\sqrt{y} = 9$$

$$y = 81$$

$$\therefore x - y = 36 - 81 = -45$$

06. (B) Let the width of the path be 'x' meters.

$$\therefore \text{New length (L)} = (19 + 2x) \text{ m}$$

$$\text{New breadth (B)} = (16 + 2x) \text{ m}$$

$$\text{Area of the path} = LB - lb$$

$$= [(19 + 2x)(16 + 2x) - 19 \times 16] \text{ m}^2$$

$$= (19 \times 16 + 38x + 32x + 4x^2 - 19 \times 16) \text{ m}^2$$

$$= 4x^2 + 70x$$

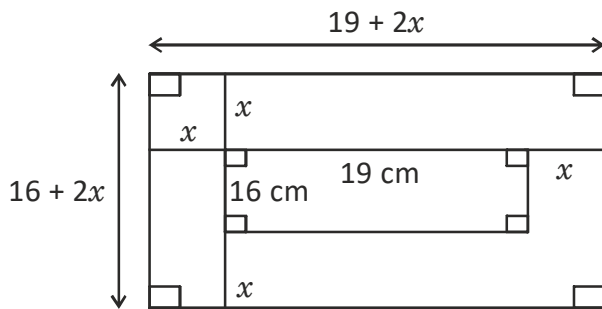

$$4x^2 + 70x = 294$$

[\therefore Given area of the path = 294 m²]

$$2(2x^2 + 35x) = 294$$

$$2x^2 + 35x = \frac{294}{2}$$

$$2x^2 + 35x - 147 = 0$$

$$2x^2 + 42x - 7x - 147 = 0$$

$$2x(x + 21) - 7(x + 21) = 0$$

$$(x + 21)(2x - 7) = 0$$

$$(x + 21) = 0$$

$x = -21$ is rejected because width never be negative

(OR)

$$2x - 7 = 0$$

$$2x = 7$$

$$x = \frac{7}{2} = 3.5 \text{ m}$$

\therefore Width of the path (x) = 3.5 m

07. (A) Given $a_{20} = a + 19d = 106$ (1)

$$a_{16} = a + 15d = 84$$
 (2)

$$a_{20} - a_{16} = (a + 19d) - (a + 15d)$$

$$= 106 - 84$$

$$a + 19d - a - 15d = 22$$

$$4d = 22$$

$$d = \frac{22}{4} = 5.5$$

$$a + 15(5.5) = 84$$
 (2)

$$a + 82.5 = 84$$

$$a = 84 - 82.5 = 1.5$$

$$a_8 = a + 7d = 1.5 + 7 \times 5.5$$

$$= 1.5 + 38.5$$

$$a_8 = 40$$

08. (A) $\alpha + \beta = \frac{-c}{b}$ & $\alpha\beta = \frac{a}{b}$

$$(\alpha - \beta)^2 = (\alpha + \beta)^2 - 4\alpha\beta$$

$$= \left(\frac{-c}{b}\right)^2 - \frac{4a}{b}$$

$$(\alpha - \beta)^2 = \frac{c^2}{b^2} - \frac{4a}{b}$$

$$(\alpha - \beta)^2 = \frac{c^2 - 4ab}{b^2}$$

$$\alpha - \beta = \pm \sqrt{\frac{c^2 - 4ab}{b^2}}$$

$$= \pm \sqrt{\frac{c^2 - 4ab}{b^2}}$$

$$= \pm \sqrt{\frac{c^2 - 4ab}{b^2}}$$

09. (C) Given $P(x) = (3x^3 - 8x^2 - 19x - 4)$
 If $P(x)$ is divided by $(3x - 2)$, then the remainder is $P\left(\frac{2}{3}\right)$

$$P\left(\frac{2}{3}\right) = 3\left(\frac{2}{3}\right)^3 - 8\left(\frac{2}{3}\right)^2 - 19\left(\frac{2}{3}\right) - 4$$

$$= 3 \times \frac{8}{27} - 8 \times \frac{4}{9} - \frac{38}{3} - 4$$

$$= \frac{-24}{9} - \frac{38}{3} - 4$$

$\therefore P\left(\frac{2}{3}\right) \neq 0 \Rightarrow (3x - 2)$ is not a factor of $P(x)$

$$P\left(\frac{-4}{3}\right) = 3\left(\frac{-4}{3}\right)^3 - 8\left(\frac{-4}{3}\right)^2 - 19\left(\frac{-4}{3}\right) - 4$$

$$= 3 \times \frac{-64}{27} - 8 \times \frac{16}{9} + \frac{76}{3} - 4$$

$$= \frac{-64 - 128 + 228 - 36}{9}$$

$$= \frac{0}{9} = 0 \Rightarrow (3x + 4)$$
 is a factor of $P(x)$

10. (D) $a = 1, \quad b = 26, \quad c = 1$

$$x = \frac{-b \pm \sqrt{b^2 - 4ac}}{2a}$$

$$= \frac{-26 \pm \sqrt{(-26)^2 - 4 \times 1 \times 1}}{2 \times 1} = \frac{-26 \pm \sqrt{676 - 4}}{2}$$

$$= \frac{-26 \pm \sqrt{672}}{2} = \frac{-26 \pm 4\sqrt{42}}{2} = \frac{2(-13 \pm 2\sqrt{42})}{2}$$

$$x = -13 \pm 2\sqrt{42}$$

11. (D) Let the usual speed (S_1) be x km/h

$$t_1 = \frac{d}{S_1} = \frac{1800 \text{ km}}{x \text{ km/hr}} = \frac{1800}{x} \text{ hours}$$

New speed (S_2) = $(x + 40)$ km/hr

$$t_2 = \frac{d}{S_2} = \frac{1800}{(x + 40)} \text{ h}$$

$$\text{Given } t_1 - t_2 = 30 \text{ min} = \frac{1}{2} \text{ h}$$

$$\left(\frac{1800}{x} - \frac{1800}{x + 40}\right) \text{ h} = \frac{1}{2} \text{ h}$$

$$\therefore \frac{1800(x + 40) - 1800x}{x(x + 40)} = \frac{1}{2}$$

$$\frac{1800(x + 40 - x)}{x^2 + 40x} = \frac{1}{2}$$

$$\therefore x^2 + 40x = 1800 \times 40 \times 2$$

$$x^2 + 40x - 144000 = 0$$

$$\therefore x^2 + 400x - 360x - 144000 = 0$$

$$x(x + 400) - 360(x + 400) = 0$$

$$\therefore (x + 400)(x - 360) = 0$$

$$\therefore x = -400 \text{ (or) } x = 360$$

$$\therefore x = 360 \text{ km/hr}$$

[$\therefore x = -400$ km/hr is rejected because speed is never negative]

(or)

$$\text{use } x = \frac{-b \pm \sqrt{b^2 - 4ac}}{2a}$$

12. (D) Given $\sqrt{3}, \sqrt{12}, \sqrt{27}, \dots$

i.e., $\sqrt{3}, 2\sqrt{3}, 3\sqrt{3}, \dots$ are in AP

$$\therefore a_{12} = 12\sqrt{3}$$

$$S_n = \frac{n}{2}[a + l]$$

$$S_{12} = \frac{12}{2}[\sqrt{3} + 12\sqrt{3}]$$

$$= 6 \times 13\sqrt{3} = 78\sqrt{3}$$

$$= \sqrt{6084 \times 3} = \sqrt{18252}$$

13. (C) Given $71x + 17y = 179 \dots\dots (1)$

$$17x + 71y = -91 \dots\dots (2)$$

$$\text{Eq (1) + (2)} \Rightarrow 88x + 88y = 88$$

$$88(x + y) = 88$$

$$x + y = \frac{88}{88}$$

$$x + y = 1 \dots\dots (3)$$

$$71x + 17y = 179 \quad \dots\dots (1)$$

$$\begin{array}{r} \text{eq (3)} \times 71 \Rightarrow 71x + 71y = 71 \\ \quad \quad \quad \quad (-) \quad \quad (-) \quad \quad (-) \\ \hline \quad \quad \quad \quad \quad \quad -54y = 108 \end{array}$$

$$y = \frac{108}{-54}$$

$$x = -2$$

$$x + (-2) = 1 \quad \dots\dots (3)$$

$$x - 2 = 1$$

$$x = 3$$

$$x - y = 3 - (-2) = 3 + 2 = 5$$

14. (B) Given $\frac{1}{3}\pi r^2 h = 1232 \text{ cm}^3$

$$\frac{1}{3} \times \frac{22}{7} \times r^2 \times 24 \text{ cm} = 3696 \text{ cm}^3$$

$$r^2 = 3696 \text{ cm}^3 \times \frac{7}{22} \times \frac{1}{24 \text{ cm}} \times 3$$

$$r^2 = 49 \text{ cm}^2 = (7 \text{ cm})^2$$

$$l = \sqrt{h^2 + r^2} = \sqrt{7^2 + 24^2}$$

$$l = \sqrt{49 + 576} = \sqrt{625}$$

$$l = 25$$

$$\text{TSA of a cone} = \pi r(l+r)$$

$$= \frac{22}{7} \times 7 \text{ cm} (25 + 7) \text{ cm}$$

$$= 22 \times 32 \text{ cm}^2 = 704 \text{ cm}^2$$

15. (D) Total out comes = $6 \times 6 = 36$

Product of the numbers 1, 2, 3, 4, 5, 6, 2, 4, 6, 8, (10), (12), 3, 6, (9), (12), 15, 18, 4, 8, (12), 16, 20, 24, 5, (10), 15, 20, 25, 30, 6, (12), 18, 24, 30, 36

\therefore Required probability

$$= \frac{\text{No. of favorable out comes}}{\text{Total out comes}}$$

$$= \frac{7}{36}$$

REASONING



17. (C) GET AWAY

18. (A) The answer is HOP, because the complete word is SHOPPING and the missing 3 letter word is HOP.

Now the sentence is

"Mom and Dad have gone SHOPPING in the local supermarket".

19. (B) $\diamond = M$; $\blacklozenge = P$; $\gg = X$;

$> = W$; $\ggg = Y$

20. (C) WH

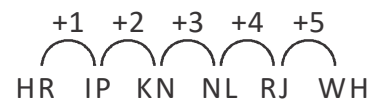

21. (B) Pesticide, pestiferous, pestilence, pestilent, pestilential

22. (B) 48 : 16 :: 513 : 171

23. (A) According to the given information,

A + S → A is the father of S

S + B → S is the father of B

B - T → B is the sister of T

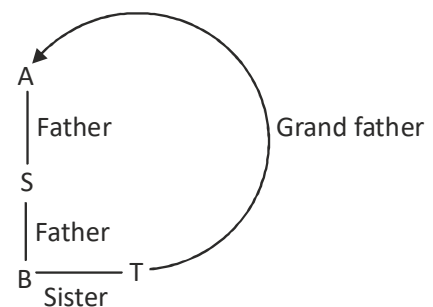

The option (A) shows that A is the grand father of T.

24. (A) The arrangement is as shown below starting with the first.

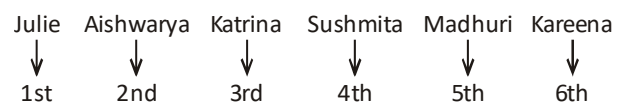

25. (C) Number of alphabets between S & Z multiplied by 2. i.e.

(A) $Z \leftarrow S \text{ (12)}$
 $6 \times 2 = 12$

(B) $P \leftarrow M \text{ (4)}$
 $2 \times 2 = 4$

(C) $R \leftarrow J \text{ (16)}$ is wrong
 $7 \times 2 = 14$

(D) $F \leftarrow D \text{ (2)}$
 $1 \times 2 = 2$

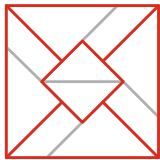

26. (D)

27. (A) The cube formed using the given nets is options (A).

28. (B) In the morning In the evening

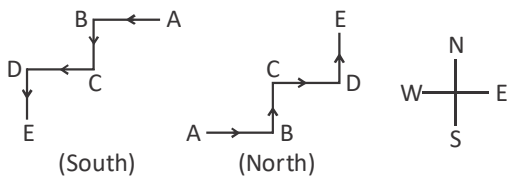

Hence, it can be either North or South.

29. (D) The figure may be labeled as shown.

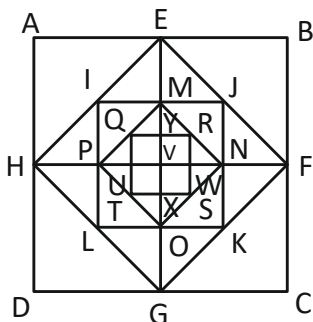

The simplest squares are QVYU, VRWY, YWSX and UYXT i.e. 4 in number.

The squares composed of four components each are IMYP, MJNY, YNKO, PYOL and QRST i.e. 5 in number.

The squares composed of seven components each are AEYH, EBFY, YFCG and HYGD i.e. 4 in number.

The only square composed of twelve components is MNOP.

There is only one square i.e. IJKL composed of sixteen components.

There is only one square i.e. EFGH composed of twenty-four components.

There is only one square i.e. ABCD which is composed of twenty-eight components.

Thus, there are $4 + 5 + 4 + 1 + 1 + 1 + 1 = 17$ squares in the given figure.

30. (C) The figure rotates 45° CW and also gets inverted in each step.

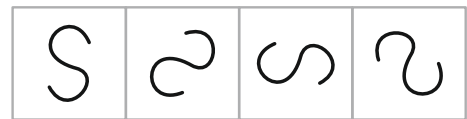

COMPUTERS

31. (C) MAX_VALUE is declared using the const keyword, making it a constant. Constants are variables whose values are fixed and cannot be changed during program execution.

32. (C) Encryption is the process of converting data into a ciphertext that cannot be easily understood by unauthorized users. It helps protect data confidentiality and integrity during transmission and storage.

33. (A) To represent the decimal number 9 in binary using 4 bits, you write it as 1001.

34. (A) PyCharm is a popular Integrated Development Environment (IDE) specifically designed for Python development, allowing users to write, edit, and execute Python code efficiently.

35. (C) Grace Hopper added the caption "First actual case of bug being found", and that's the first time anyone used the word bug to describe a computer glitch.

36. (B) The For loop starts i at 1 and increments i by 2 each time (Step 2) until i reaches 10 (To 10). Therefore, it prints the values of i that are 1, 3, 5, 7 and 9.

37. (B) While PowerPoint supports multiple sound file formats, including .mp3, .wav is a common format for inserting sounds into presentations due to its compatibility and quality.
38. (B) By default, all cell references are relative references. When copied across multiple cells, they change based on the relative position of rows and columns. For example, if you copy the formula =A1+B1 from row 1 to row 2, the formula will become =A2+B2
39. (B) A multi-user operating system allows multiple users to access and use the computer resources simultaneously. In a computer lab scenario where multiple students share the same resources, a multi-user operating system would be the most suitable choice to manage user accounts, permissions, and resource allocation.
40. (B) TCP (Transmission Control Protocol) is responsible for ensuring reliable and ordered delivery of data packets over a network. It provides error checking, flow control, and retransmission of lost packets to ensure that data reaches its destination accurately and in the correct order.
41. (C) ICT contributes to healthcare by enabling telemedicine and remote patient monitoring, allowing healthcare professionals to deliver medical services and monitor patients remotely. This enhances access to healthcare, particularly for individuals in remote or underserved areas, and can improve patient outcomes through timely intervention and monitoring
42. (B) Python has seen widespread adoption across various domains due to its simplicity, readability, and versatility. It is commonly used in web development, machine learning, data science, artificial intelligence, and many other areas.
43. (C) The enctype attribute in the <form> element is used to specify the type of form data encoding when submitting files using the form. It is set to multipart/form-data when uploading files using the form.
44. (C) Sending unsolicited emails is not a common or ethical method of finding people on the internet. It is often considered spam and can violate privacy laws and regulations. Common methods include using social media platforms, searching public records databases, and using online directories and search engines.
45. (B) In this scenario, the appropriate action is to insert a new field named "Department" into the existing "Employee" table. This allows for the addition of the desired information without losing any existing data or structure.

ENGLISH

46. (D)
47. (C)
48. (C)
49. (D)
50. (D)

=====
The End
=====